

Content

Glossary and pictorials symbols	2
Operator safety	3
Description	3
Fitting the system	4
Power supply	6
Scanbox	7
Display	7
Transducer colour codes and plug assembly	8
Speed transducer	8
Flow transducer	9
Optional transducers	10
Start-up	11
Reading chosen volume rate	11
HM 1500: Changing the desired volume rate for alarm	11
HC 2500: Changing the volume rate	11
Menus	13
General keystroke	13
Keystroke menu tree chart	14
Main menu	15
Display readout	16
Tank contents	17
Calibration	18
Alarms	23
Sensor test	25
Area meter	26
Mistblowers and HM 1500/HC 2500	26
Storage	27
Emergency operation	27
Fault finding	27
Technical specifications	29
Chart for recording values	30
Extended menu	30
EC Declaration of Conformity	32
Parts	33

Controller 2500 & Monitor 1500 ver. 1.13 Instruction book

673294-GB-2002/09

HARDI INTERNATIONAL A/S is without any obligation in relation to implements purchased before or after such changes.

HARDI INTERNATIONAL A/S cannot undertake any responsibility for possible omissions or inaccuracies in this publication, although everything possible has been done to make it complete and correct.

Published and printed by HARDI INTERNATIONAL A/S.



We congratulate you for choosing a HARDI plant protection product. The reliability and efficiency of this product depend on your care. **Read and pay attention** to this instruction book. It contains information for the efficient use and long life of this quality product.

Glossary and pictorials symbols

HM 1500	HARDI Monitor 1500.
HC 2500	HARDI Controller 2500.
Scanbox	Junction box for HM 1500 and HC 2500.
Transducer	Device that transforms variations to a signal. Also called a sensor.
[x] or [y]	Variable figures.
PPU	Pulses per unit. For flow calibration. The unit measure is litre.
UPP	Unit per pulse. For speed calibration. The unit measure is metre.
PPR	Pulses per revolution. For revolutions calibration.
BK	HARDI manual control unit.
BK/EC	HARDI manual control unit (with electric on/off and pressure regulation).
EC	HARDI electric control unit.
EVC, ESC or CB	Electric control unit (without main valve).



Description/Notes



Winter storage



Warning



Operational problems



Assembly



Technical specifications



Operation/Use



EC Declaration of Conformity











NOTE: Text shown in square brackets or in the rectangular window will be seen on the display.
E.g. [MAIN MENU]

MAIN MENU
Display readout

Operator safety

Watch for the WARNING symbol . Your safety is involved so be alert! Note the following recommended precautions and safe operating practices.

-  Read and understand this instruction book before using the equipment. It is equally important that other operators of this equipment read and understand this book.
-  Turn electrical power off before connecting and disconnecting the display and transducers, servicing or using a battery charger.
-  If an arc welder is used on the equipment or anything connected to the equipment, disconnect power leads before welding.
-  Test with clean water prior to filling with chemicals.
-  Keep children away from the equipment.
-  Do not use a high pressure cleaner to clean the electronic components.
-  Press the keys with the underside of your finger. Avoid using your fingernail.
-  If any portion of this instruction book remains unclear after reading it, contact your HARDI dealer or HARDI service personnel for further explanation before using the equipment.

Description

The HARDI Monitor 1500 and HARDI Controller 2500 are for use in agricultural and horticultural production. HM 1500 is a monitor whereas HC 2500 permits automatic control of application rate.

Main components are:

- Display
- Scanbox junction box
- Flow transducer
- Speed transducer

The matrix display has two lines permitting two lots of information to be shown at the same time. Display readout includes dosage applied, speed, liquid rate per minute, total covered area, total volume sprayed and 9 trip tellers for area covered and volume sprayed. It is illuminated internally so readout is possible even for night-time work.





Functions include correct area with closure of up to 8 spray boom sections, alarm functions for dosage and minimum tank contents and possibility for audio/visual alarm.

The transducers utilised are chosen for long service life and good signal quality. Speed, area switch and revolutions transducer is the same component. The flow transducer has a diode built into the housing to aid servicing. As the rotor turns, the diode will flash thereby indicating it functions.

The system has a non-volatile memory with no battery which simplifies storage. All parameters in the menus are saved in the display's memory and are not lost when the power is disconnected. The materials and electronics for the components have been developed to last many years under agricultural conditions.

Options include a 4-20 mA transducer (e.g. pressure), revolutions transducer, area meter transducer and switch box for boom sections when used with BK or BK/EC control unit (only for HM 1500).



Fitting the system

Please note the configuration and connections for your system.

HM 1500 Monitor with manual control unit (BK, BK/EC)

The active boom width is always the total boom width.

The system can not automatically calculate correctly when one or more boom sections are turned off.

1. HM 1500 display
2. Display connector cable
3. Scanbox (fuse inside)
4. On/off switch
5. Speed transducer
6. Flow transducer
7. To 12 Volt power supply
8. Switch box connector cable (not used)

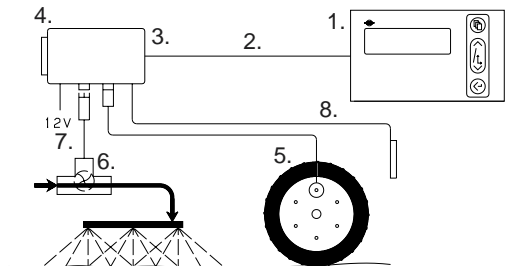

HM 1500 Monitor with manual control unit (BK, BK/EC) and switch box for boom sections

Active boom width is calculated automatically.

The control box switches are set to correspond with the boom sections.

NOTE: Extended menu setting:

[**Control box**] is [**Connected**].

See “Extended menu”.

1. HM 1500 display
2. Display connector cable
3. Scanbox (fuse inside)
4. On/off switch
5. Speed transducer
6. Flow transducer
7. To 12 Volt power supply
8. Switch box connector cable
9. Switch (control) box

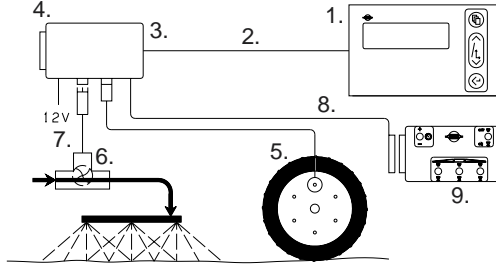

HM 1500 Monitor with electric control unit (EC, EVC, ESC, CB)

Active boom width is calculated automatically when the boom sections are operated.

NOTE: Extended menu setting:

[**Control box**] is [**Connected**].

[**ON/OFF valve**] is [**Not present**] for EVC, ESC and CB.

See “Extended menu”.

1. HM 1500 display
2. Display connector cable
3. Scanbox (fuse inside)
4. On/off switch
5. Speed transducer
6. Flow transducer
7. To 12 Volt power supply
8. Control box connector cable
9. Control box for electric control unit
10. Electric control unit
11. Connector cable from control unit

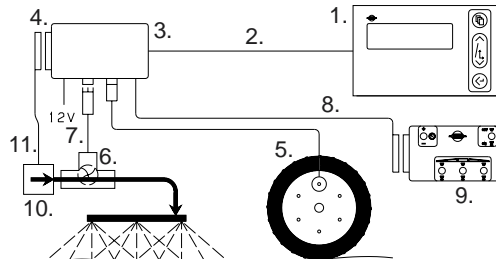



HC 2500 Controller with electric control unit (EC, EVC, ESC, CB)

Active boom width is calculated automatically when the boom sections are operated.

NOTE: Extended menu setting:

[**ON/OFF valve**] is [**Not present**] for EVC, ESC and CB.

See "Extended menu".



1. HC 2500 display
2. Display connector cable
3. Scanbox (fuse inside)
4. On/off switch
5. Speed transducer
6. Flow transducer
7. To 12 Volt power supply
8. Control box connector cable
9. Control box for electric control unit
10. Electric control unit
11. Connector cable from control unit

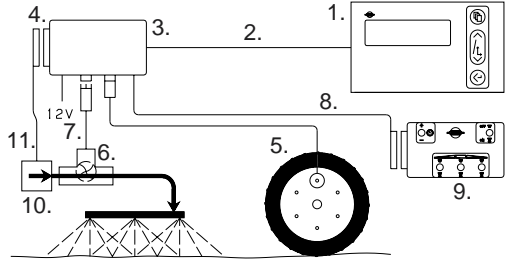

Power supply

The power supply is 12 Volt DC.

Brown wire is positive "⊕".

12V

Blue wire is negative "-".



Power supply must come directly from the battery. The wires must have a cross-sectional area of at least 1.0 mm² to ensure sufficient power supply.



NOTE: Do not connect to the starter motor or generator/alternator. Warranty is void if this is done.

Use the HARDI Electric distribution box (Ref. no. 817925) if the tractor has a doubtful wiring.

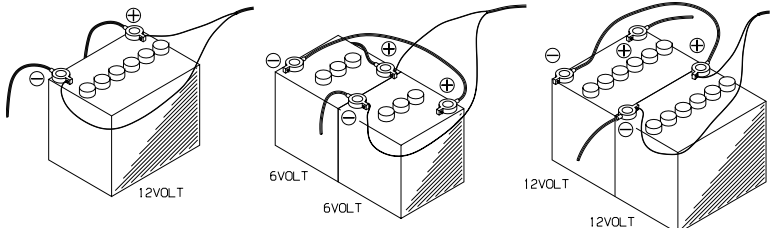

T1165-0002

Scanbox

The box is not water proof and must be protected from moisture. Place in the tractor cabin for example, behind the driver seat. It should be secured from movement.

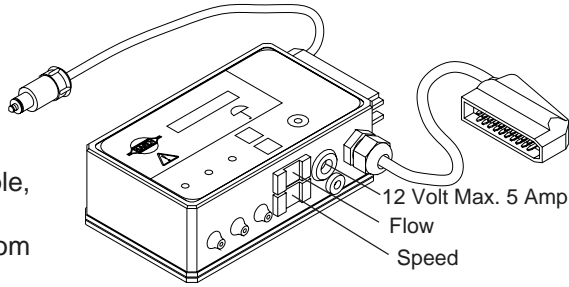

NOTE: If the tractor is without a cabin, it is recommended to cover the Scanbox and display with a rain protection bag. This is available as an optional extra.

Fuses are located inside the box.

Fuse 1.25 T Amp Slow acting (HARDI ref. no. 261589)

The 2-pole 12 Volt socket has a maximum rating of 5 ampere.

Fuse 5.0 Amp Quick acting (HARDI ref. no. 261762)

Display

The display is fitted in the tractor cabin at a convenient place. Use only the supplied screws.

The mounting plate (A) is utilised to fit the display together with the switch box. The display can also be fitted to a flat surface with “Velcro” tape.

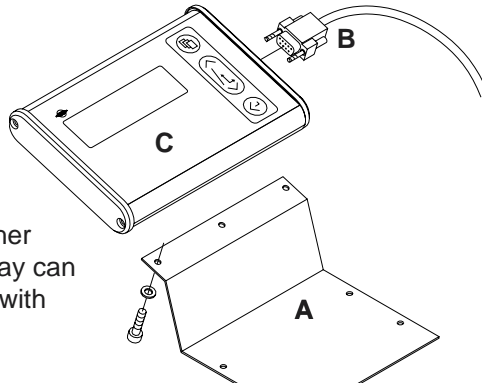

Place “ **Quick guide**” sticker at **C**

NOTE: Power must be disconnected before plug (B) is connected to the display.





Transducer colour codes and plug assembly

1. Shorten cable to a suitable length.
2. Assemble as shown.
3. Run tie strap through hole under cable grip and secure cable to plug housing.
4. Trim tie strap length and assemble the housing. Tag the speed transducer by folding the identification sticker around the cable.
5. Secure plug housing with a tie strap.

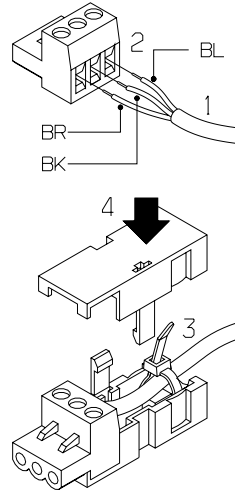

HARDI transducers colour codes are as follows. Includes speed, flow, area meter, revolutions and pressure transducers.

Wire colour	Code	Connection for transducer
Brown	BR	12 Volt supply
Black	BK	GND
Blue	BL	Signal

Speed transducer

Speed transducer is fitted as shown.

Hole size is 4.5 mm.

Magnets must be placed an equal distance (and at least 150 mm) from one another.

Recommended number of magnets fitted are as follows:

Tractor front wheel (rim size up to 20")	4
Tractor rear wheel (rim size over 20")	6
Transmission drive-shaft	1

The south side of the magnet must face the transducer.

Distance between them must be 5 to 7 mm.

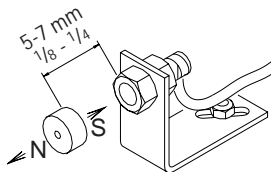
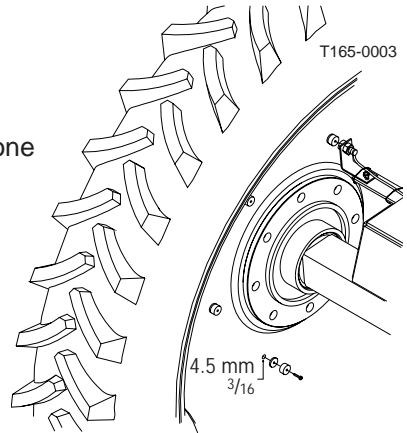

T165-0004



Flow transducer for BK, EVC and ESC control unit

For BK and EVC control unit, the housing is fitted just prior to the distribution valves. Flow transducer is fitted to the housing and connected to the Scanbox with the a 3 poled plug.

For ESC control unit, the flow housing is fitted just prior to the control unit on the delivery hose from the pump. Flow transducer is fitted to the housing and connected to the Scanbox with the a 3 poled plug.

BK

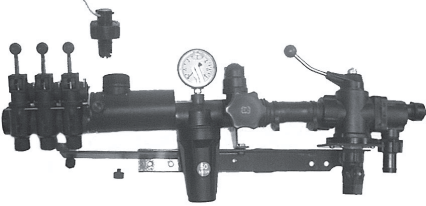

BK

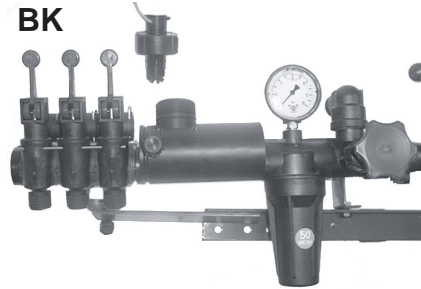

EVC

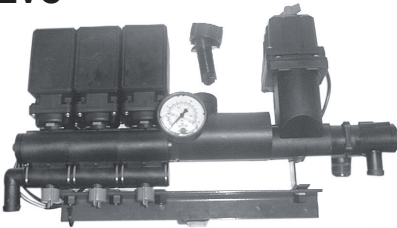

ESC

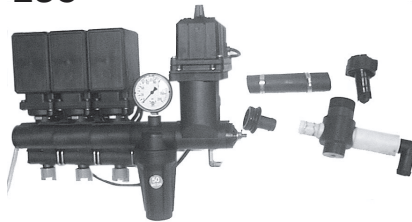

Flow transducer EC control unit

1. The distribution valve unit is detached from the main ON/OFF valve unit. Note the orientation of the ball seat and remove it from the distribution valve unit.
2. Mount the flow transducer housing just before the distribution valves.
3. Attach distribution valves with flow housing with the ball seat on the end to main ON/OFF valve unit.
4. Flow transducer is fitted to the housing and connected to the Scanbox with the a 3 poled plug.

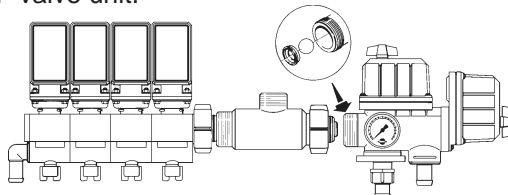



Optional transducers

Revolutions and area-meter transducer

The south side of the magnet must face the transducer.

Distance between them must be 5 to 7 mm.

An adjustable hose clamp can be used to attach the magnet to the shaft.

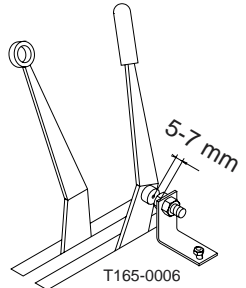
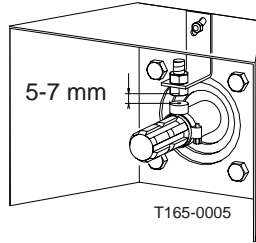

Analog transducer

Input is 4 to 20 mA.

Transducer cables are fed through the Scanbox grommets. Connection is directly to the Scanbox circuit board.

NOTE: A 2 metre cable extension set with plugs and sockets is available. HARDI ref. no. is 741610.

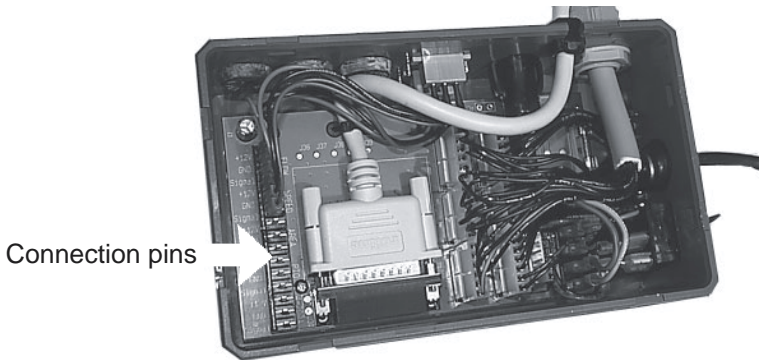

Cables

All the cables and wires must be routed so they do not get pinched, snagged or melted. The transducer cables should be shortened if necessary.



NOTE: Although the system meets standards EN 50081-1 (1992) for generic emission and EN 50082-2 (1995) for generic immunity, some communication systems (e.g. 2 way radio, cellular telephones) may cause interference with the sprayer computer. Keep communication system units and cabling away from the sprayer computer units and cabling. If interference is noted, avoid using the communication system.

Start-up

After connecting the plugs, the power is turned on at the Scanbox. Model, version number and boom sections and size is displayed briefly.

Display

1. Matrix display, upper line.
2. Matrix display, lower line.
3. Key for menu.
4. Arrow keys.
 - For programmed application rate.
 - With HM 1500, the value is used for the dose alarm.
 - To get to (scroll).
 - To alter a parameter.
5. Key to accept or get out of a menu.

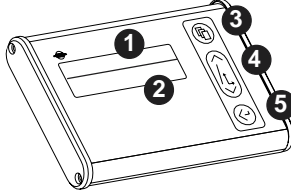

NOTE: Press the keys with the underside of your finger. Avoid using your fingernail.

Reading chosen volume rate

To read the chosen volume rate, press briefly either arrow keys on the display. The chosen rate is shown.



The main picture will return again after 5 seconds or if you press  accept key.

HM 1500: Changing the desired volume rate for alarm

The desired rate must be entered if you wish to operate with the alarm. Press either arrow keys on the display. The rate per area is shown. If the key is pressed again it will raise or lower the chosen rate. When the key is released the display shows the new rate for a moment and then returns to the main picture.

HC 2500: Changing the volume rate

The rate can be changed:

- Automatically, by changing the desired rate on the HC 2500 display.
- Manually, by raising and lowering the pressure on the control box.





Automatic dosage

To alter the chosen application rate, press either arrow keys on the display. The chosen quantity applied per area unit is shown. If the key is pressed again it will raise or lower the chosen rate. When the key is released the display shows the new rate for a moment and then returns to the main picture.

NOTE: A minimum speed of 2.0 km/h is needed before the system will regulate automatically.



Manual dosage

To dose in manual mode, use the pressure switch on the control box. With HC 2500, the manual mode is indicated on the bottom line with a flashed text [**MAN.**] over the displayed information. Bottom line is cleared when [**MAN.**] is displayed.



To go from manual to automatic dosage, briefly touch the arrow key on the HC 2500.



Reading and reset of area trip

Area trip from 1 to 8 (**Y**) can be used for individual areas.

Area trip 0 is a tally of area trips 1 to 8. The treated area is memorised when the system is switched off.

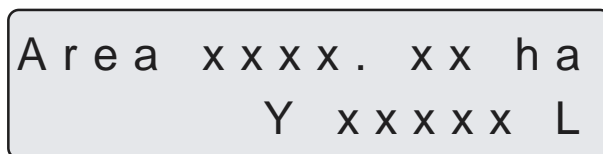

1. Press enter key for area covered and volume sprayed.
2. Press enter key again to return. If is not pressed again it will return to the main picture after 15 seconds.



To reset the active register press the enter key continuously and a 5 second countdown will commence.

Reset of a register can be stopped if the enter key is released.

Alarms

Alarm warnings [**Vol. rate alarm**] or [**Tank alarm**] are flashed for 3 seconds at a time on the top line over the displayed information.

Menus

Parameter selection is carried out from the menu key.



The menus can be scrolled to and fro with the arrow keys.



The upper line, in capital letters, displays the menu you are in.

The lower line, in small letters, displays the choices you have. When the chosen menu is shown, press the menu key again to open the menu.

When modifying a parameter, prolonged pressure on the arrow key will generally cause the data shown on the display to alter faster.

After the parameter is modified, press the accept key.

The display then changes back to the previous picture.





Press the accept key until the display returns to the main display.

There are 2 menu systems, the operator menu for general use and an extended menu for initial set-up of the system. To access the extended menu, press both arrow keys at the same time until the menu changes.

General keystroke

Press  to enter menus.

Press  to find desired menu.

Press  to enter menu.

Press  to find desired sub-menu or alter parameter.

Press  to continue in the menu if needed.

Press  to accept and exit the menu.

Press  Repeat to exit the menus and go back to the normal display function.



Keystroke menu tree chart

Press  to read or alter (HC 2500) chosen volume rate.

Press  to read or reset area trip.

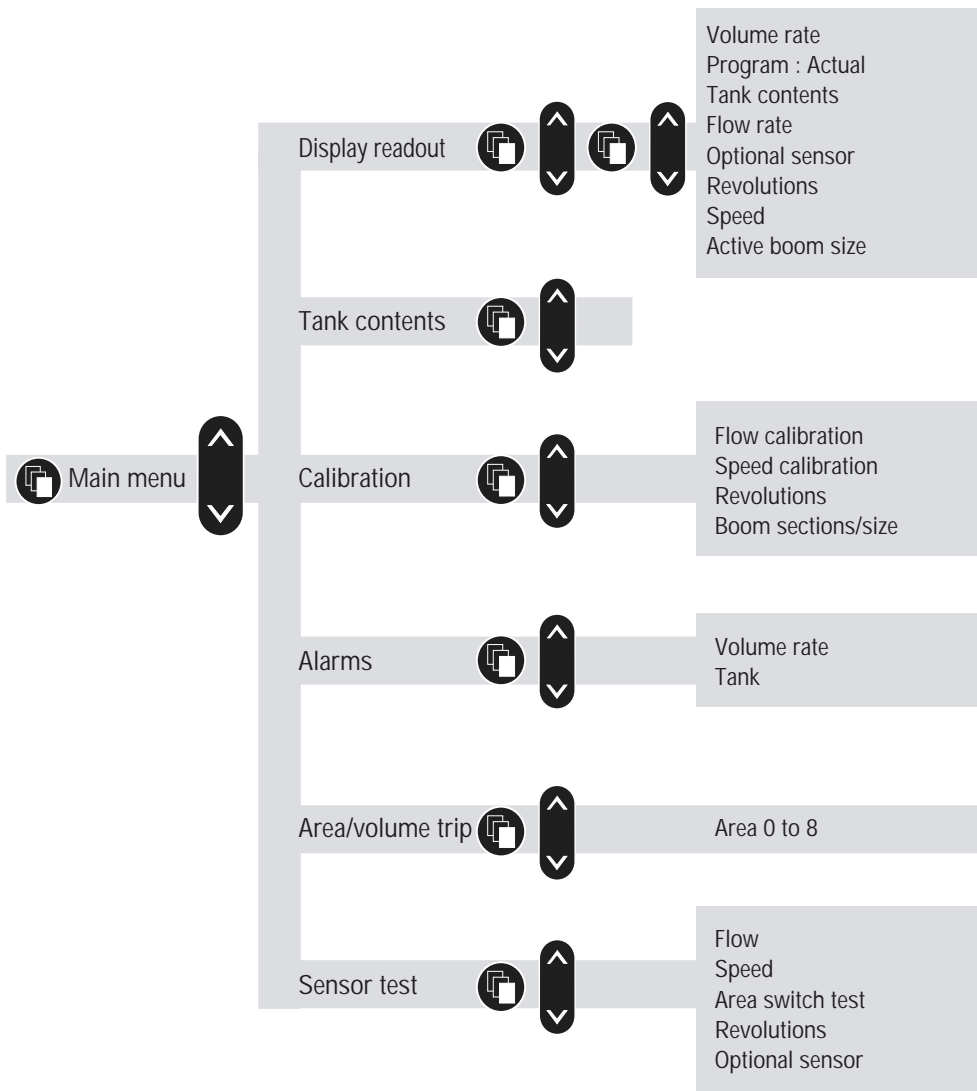

Main menu

The upper line will read [**MAIN MENU**].

The lower line displays the choices.

M A I N M E N U
D i s p l a y r e a d o u t

To choose what is to be displayed on screen.

T a n k c o n t e n t s

To change the indicated tank contents.

C a l i b r a t i o n

To access calibration menus.

A l a r m s

To set alarm parameters.

A r e a / v o l u m e t r i p

To select register to record or read area covered and volume sprayed.

S e n s o r t e s t

To test that the transducers function.





Display readout

It is possible to freely choose which function is to be shown on the upper or lower line of the display.

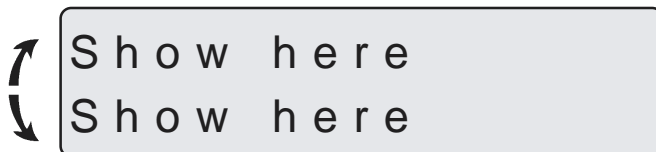

To choose where to show information.

Press arrow key to move [**Show here**] from the upper to lower line.
Press menu key to continue.

The upper line will read [**DISPLAY READOUT**].

The lower line displays the choices.



To show the actual application rate.

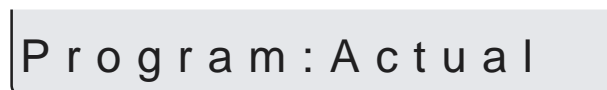

To show the programmed and actual application rate.



To show the tank contents.

If two tanks are used, the tank contents is the total contents.

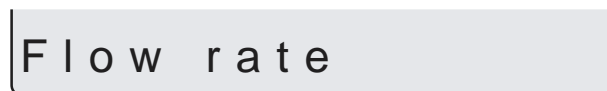

To show the flow rate.

Optional sensor

To show readout from optional analog transducer.

Revolutions

To show revolutions.

Speed

To show driving speed.

Active boom size

To see the active boom size.

Tank contents

If the sprayer is partially refilled or refilled the tank contents can be adjusted.

See Extended menu to set tank size.

TANK CONTENTS
XXXX L

Press menu key and use arrow keys to raise or lower value.





Calibration

It is necessary to set the correct boom width and calibrate the flow and speed transducer before using the system. Calibration of the optional revolutions transducer is necessary if it is fitted.

Boom size

CALIBRATION
Boom size set

For setting of number of boom sections and width.

Correct work width for each boom section is necessary to calculate dosage and area covered.

Method

BOOM SIZE SET
Total sections x

1. Use arrow key to set number of boom sections and press menu key. Maximum number of sections is 8. Press menu key to continue. For mistblowers, number of sections is typically 2.

Sec. y Size x . xx m

2. Use the arrow key to increase or decrease section work width. Press menu key to continue to next boom section. After the last section, press the accept key. The display will briefly show the total width.

Flow calibration

CALIBRATION
Flow calibration



The flow transducer can be calibrated theoretically or with two practical methods. For the sake of accuracy, the practical methods are preferred. Practical calibration is done with clean water. The Flow Tank method is more time consuming, but is more accurate than the Flow Nozzle method.

When changing to nozzles with more than a 100% increase or decrease in output, it is recommended to re-calibration the flow transducer.

Calibration is recommended to be carried out at least once during the spraying season.

Use the chart at the back of the book to record the values.

Flow constant

FLOW CALIBRATION

Flow constant

To change the flow constant theoretically.

During theoretical flow calibration the number of pulses per unit are shown on the display.

For example, [**120.0 PPU**] indicates the number of pulses which theoretically come from the flow transducer whilst 1 litre of liquid passes through. Approximate PPU values for different flow housings are as follows:

Housing	Code for housing	Flow range l/min	PPU value	Orifice mm
BK	White	5 - 150	105.0	13.5
BK & EVC	One outside groove	5 - 150	120.0	13.5
BK	Black	10 - 300	60.0	20.0
EC	White	5 - 150	118.0	13.5
EC	Black	10 - 300	59.0	20.0
EC S/67	One outside groove	5 - 150	128.0	13.5
S/67	Two outside grooves	35 - 600	125.0	36.0

FLOW CONSTANT

xxx.x PPU



Nozzle method

FLOW CALIBRATION
Nozzle method

During practical flow calibration the individual nozzle output on the display is compared to the actual individual nozzle output. The output displayed is corrected to read the actual output. For correct calibration it is necessary to know the number of nozzles on the boom.

Method

NOZZLE METHOD
Total Nozzles xxx

1. The number of nozzles is set with the arrow key to read the actual number of nozzles to spray. Press the menu key to continue.
2. Open all boom sections.
3. Turn the main ON/OFF valve on.
The display unit will then show the individual nozzle output per minute.

Flow xx.xx L/min

4. Using a HARDI calibration jug, check the actual nozzle output per minute. It is recommended that an average of several nozzles be taken.
5. Correct the output shown on the display with the arrow key to read the average output measured with the calibration jug.
The display will briefly show the new calibration value PPU when returning to the main display picture.

Tank method

FLOW CALIBRATION

Tank method



During practical flow calibration the tank is partly emptied through the nozzles. Whilst emptying, the display calculates the quantity emptied on the basis of the actual calibration value (PPU). The quantity displayed is compared with the quantity actually dosed. This can be according to the tank contents level indicator or by weight difference before and after. The quantity displayed is corrected to read the quantity actually dosed.

Method

1. Place the tank on level ground and fill up with water until the level reaches a unique mark on the tank contents level indicator, e.g. 1000 litres.
2. Open all boom sections.
3. Open menu and turn the main ON/OFF valve on.

TANK METHOD
Sprayed xxxxL

The display unit will then begin to count the volume being emptied through the nozzles.

4. When for example, 600 litres have been emptied out, as shown by the tank contents level indicator, the main ON/OFF valve can be turned off.
5. Correct the volume shown on the display with the arrow key to read the volume shown on the tank contents level indicator. The display will briefly show the new calibration value PPU when returning to the main display picture.



Speed calibration

CALIBRATION
Speed Calibration

The speed transducer can be calibrated theoretically or practically.
The practical method is recommended.

Speed constant

SPEED CALIBRATION
Speed constant

The theoretical speed constant, units per pulse (UPP), is the distance in metre on the circumference of the wheel between magnets.

For example, if the wheel circumference is 2.00 m and 4 magnets are fitted, UPP is 0.5000.



SPEED CONSTANT
XXXXX UPP

Speed practical

SPEED CALIBRATION
Practical

Practical calibration of speed is done by driving a measured distance and correcting the display so that the actual and the calculated distances are the same.

Theoretical speed calibration should be carried out before practical speed calibration.

Calibration should take place in the field with a half full tank and normal working tyre pressure in order to obtain the wheel's real "working radius".



Method

1. Measure a distance not less than 75 metres.
2. Park the tractor at the start of the measured distance.
3. Open menu. When zero distance [0 m] shows, drive the measured distance.

PRACTICAL
Measured xxx m

4. Correct the distance shown on the display with the arrow key to read the actual distance

Revolutions calibration

CALIBRATION
Revolutions cal.

For calibration of revolutions transducer.

REVOLUTIONS CAL.
x . x PPR

The constant, pulse per revolution (PPR), is
the number of pulses for one revolution.

For example, if one magnet is fitted, the PPR is 1.0.

Alarms

There are 2 alarms, a tank alarm for low tank contents and a volume rate alarm for over or under application. When outside the alarm parameters, the relevant warning will flash. A beeper can also be activated.

ALARMS
Tank alarm

Low tank contents alarm.



Activated at xx %

Suggested setting is 10%. For no alarm, set at 0 %.

Audio off

The beeper can be activated [**on**] or de-activated [**off**] by pressing the arrow key.

ALARMS

Vol. rate alarm

Volume rate alarm for over or under application for more than 20 seconds.

Activated at xx %

Suggested setting is 5%. For no alarm, set at 0 %.

Audio off

The beeper can be activated [**on**] or de-activated [**off**] by pressing the arrow key.

Area/volume trip

It is possible to choose up to 9 area trip meters (0 to 8). [**Area 0**] is a total for all areas treated. When any of the other areas are used, the treated area and volume will also be registered automatically in [**Area 0**].

AREA/VOLUME TRIP

Area x

For reset of [**Area / Volume Trip**], see “Reset of area trip”.

Sensor test

All readouts are in accumulated counts, i.e. one signal gives one count, except for the optional (analog) transducer that is read in milli-ampere. Follow instructions on the display.

SENSOR TEST
Flow test

To test the flow sensor.

Spin rotor xxx

Remove transducer from flow housing and spin rotor.
Every second magnet will give a count, indicating correct function.
See also "Testing flow transducer".

Speed test

To test the speed sensor.

Drive slowly xxx

Every magnet will give a count, indicating correct function.
See also "Testing speed transducer".

Area switch test

To test the area-meter switch.

Magnet To Sens. Off

Without magnet.





Magnet To Sens. On

With the south side of the magnet facing the transducer at a distance of 5 to 7 mm. This indicates correct function.

Revolutions test

To test the revolutions sensor

Turn slowly xxx

Every magnet will give a count, indicating correct function.

Optional sensor

To test the optional transducer.

Area meter

For HM 1500 with manual control unit, the area meter will register area continuously when the sprayer is disconnected. When the south side of the magnet is located directly in front of the transducer, the area meter will stop registering area.

When using a HM 1500 with manual control unit and switch box, or HC 2500 with EC control box, all the switches must be turned on.

If you do not want to utilise the area meter transducer, the main on/off switch can be used to start and stop the area register.

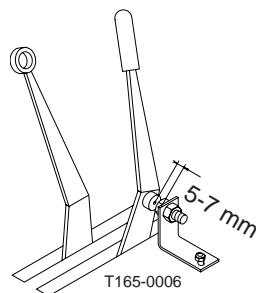

Mistblowers and HM 1500/HC 2500

Points to note if the system is used on a mistblower.

- Work width is the same as the spray width of the mistblower.
- Not active switches on the control box are set to zero work width.
- Use the Tank method to calibrate the flow transducer.
- Blower fan revolutions can be read in the revolutions readout.

Storage

When the tractor and sprayer is parked, disconnect the power supply to the Scanbox. This will stop the system from using power. The display and Scanbox should be protected from moisture and should be removed if the tractor does not have a cabin.



Emergency operation

The system is added to a standard electric control unit without any modifications to the wiring. Should there be a problem when using the HC 2500 disconnect the Scanbox from the control unit and connect the cable from the control unit to the control box. Spraying can now be continued.



Fault finding

Fault	Cause	Remedy
No start-up.	Check polarisation is correct. Check the fuse in the Scanbox.	Change fuse. (use 1.25 T Amp).
Blinking back-light. No "bip" sound at start-up.	Poor power supply.	Check battery, cabling and connections.
Displayed area larger than actual area.	Field was not rectangular. "Tramlines" narrower than spray width.	Measure "tramline" width.
Displayed volume larger than actual volume.	Pressure equalisation valve leaks.	Replace seals.

Fine tuning the flow constant - PPU

Calibration of the flow transducer is carried out with clean water but small changes may occur when adding pesticides or fertiliser. This will effect the final readings. This is typically noted when the volume displayed on the display does not equal the actual known volume that was sprayed out. The below formula can be used to "fine tune" the flow transducer PPU.

$$\text{New PPU} = \frac{\text{Original PPU} \times \text{Displayed Volume}}{\text{Sprayed Volume}}$$

For example, the spray tank is filled with 2400 litres of spray liquid. When sprayed out, the display showed a total of 2300 litres. (Original PPU = 120.0)

$$\text{New PPU} = \frac{120.0 \text{ (Original PPU)} \times 2300 \text{ (Displayed Volume)}}{2400 \text{ (Sprayed Volume)}} = 115.0$$



Note the relation is inverse:

- To raise the displayed volume, the PPU is lowered.
- To lower the displayed volume, the PPU is raised.

Testing flow transducer (Ref. no. 728816)

Wire connections: BROWN wire to positive of 12 volt battery.
BLACK wire to negative.
BLUE wire to multimeter positive.

1. Check the rotor turns freely.
2. Each vane in the rotor has a magnet in it with the pole facing out.
Check that the 4 magnets are present.
3. Check every second magnet has the same pole orientation so the rotor magnets are N - S - N - S.
4. Connect negative from multimeter to negative of battery.
5. Set multimeter to DC volt.
6. By turning the mill wheel slowly, this will register approx. 8.0 +/- 1 volt with the diode on and 0.3 +/- 0.1 volt with the diode off with every second magnet.

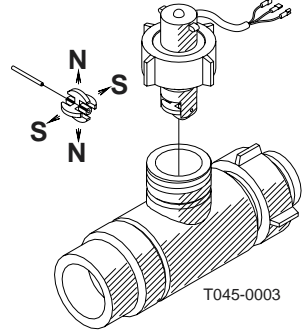

Testing speed transducer (Ref. no. 729058)

Wire connections: BROWN wire to positive of 12 volt battery.
BLACK wire to negative.
BLUE wire to multimeter.

1. Connect negative from multimeter to negative of battery.
2. Set multimeter to DC volt.
3. By bringing the south pole of a magnet (distance 5 mm +/- 2 mm) by the transducer, this will register 0.3 +/- 0.1 volt.
4. By removing the magnet, this will register 7.0 +/- 1.0 volt.

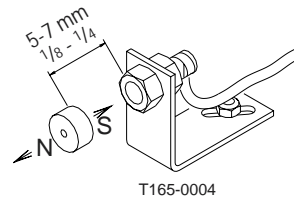

Technical specifications

Supply voltage	12 Volt DC
Minimum supply	11 Volt DC
Maximum supply	16 Volt DC
Maximum peak	20 Volt DC
Ambient temperature	- 10° C to + 55° C
Memory	Flash PROM non-volatile
Digital transducers	Square signal
Update frequency	4 times per second
Trigger high	5.0 to 12.0 Volt DC
Trigger low	0.0 to 0.5 Volt DC
Analog transducers	
Supply	Loop
Input	4 to 20 mA
Minimum speed for volume regulation	2.0 km/h

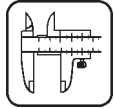

Flow ranges for the flow transducers

Identification code	Orifice	Flow
White	13.5 mm	5 to 150 l/min
Black	20.0 mm	10 to 300 l/min
One outside groove	13.5 mm	5 to 150 l/min
Two outside grooves	36.0 mm	35 to 600 l/min

Pressure drop over 13.5 mm orifice is 1 bar at 150 l/min.

Packaging information

Materials used for packaging are environmentally compatible.
They can be safely deposited or they can be burnt in an incinerator.

Recycling

- Cardboard: Can recycle up to 99% and therefore should be put into the waste collection system.
Polyethylene: Can be recycled.

When the HM 1500 / HC 2500 has completed its working life, it must be thoroughly cleaned. The synthetic fittings can be incinerated.
The printed circuit boards and metallic parts can be scrapped.



Chart for recording values

Menu	Function	1 - Values	2 - Values	3 - Values
	Nozzle /Colour			
[Flow constant]	Flow PPU			
[Speed constant]	Speed UPP			



Extended menu

Access the extended menu by pressing both arrow keys at the same time until the menu changes.

The extended menu written in English only.



NOTE: Re-start the system after leaving the Extended menu.

Menu	Function [choices]
[Language]	To select language. [GB, DK, F, E, D, Cz, SF, NL, I, S]
[Unit]	To set unit of measurement. [Metric, USA]
[ON/OFF valve]	To select EC or EVC/ESC/CB control unit. [Present, not present]
[Pressure system]	To select pressure system. [Equalisation, No equalisation]
[Control box]	To indicate control box connection to Scanbox. [Connected, Not connected]
[Tank volume max]	To pre-set tank volume indicated at start-up.
[Analog adjust]	To calibrate the optional transducer. [max., min., offset in mA]
[Analog unit text]	To choose the unit of measurement. [Bar, PSI, deg C, deg F, % R.H]
[Regulation con.]	For the sensitivity of the pressure regulation valve.
[Change SW ver.]	To permit change or update of software.
[Master reset]	For factory use only.
[Area totals]	To see total area covered and volume sprayed.
[Scanbox]	For factory use.

Default setting

Text	For HC 2500*	For HM 1500**
[Language]	GB	GB
[Unit]	Metric	Metric
[ON/OFF valve]	Present	Present
[Pressure system]	Equalisation	Equalisation
[Control box]	Connected	Not Connected
[Tank size]	2000 l	2000 l
[Analog adjustment]	max. 10 min. 0 offset in mA 0 mA	max. 10 min. 0 offset in mA 0 mA
[Analog unit text]	Bar	Bar
[Regulation con.]	0%	0%
[Flow PPU]	120.0	120.0
[Speed UPP]	1.0000	1.0000

HC 2500*

For EVC, ESC or CB control unit set:

[**ON/OFF valve**] to [**Not present**]

HM 1500**

For BK, BK/EC or EC control unit with switch (control) box for boom sections set:

[**Control box**] to [**Connected**]

For EVC, ESC or CB control unit set:

[**ON/OFF valve**] to [**Not present**]

[**Control box**] to [**Connected**]

NOTE: Re-start the system after leaving the Extended menu.





EC Declaration of Conformity

Manufacturer,

HARDI INTERNATIONAL A/S
Helgeshøj Allé 38
DK 2630 Taastrup
DENMARK

Importer,

declare that the following product;

.....
.....

Adhere extra shipping package labels to inside cover.

.....

was manufactured in conformity with the provisions in the EMC directive 89/336/EEC, EN 50081-1 (1992) (generic emission) and EN 50082-2 (1995) (generic immunity).

Taastrup 15/09/2002

Lars Bentsen
Product Development Manager
HARDI INTERNATIONAL A/S

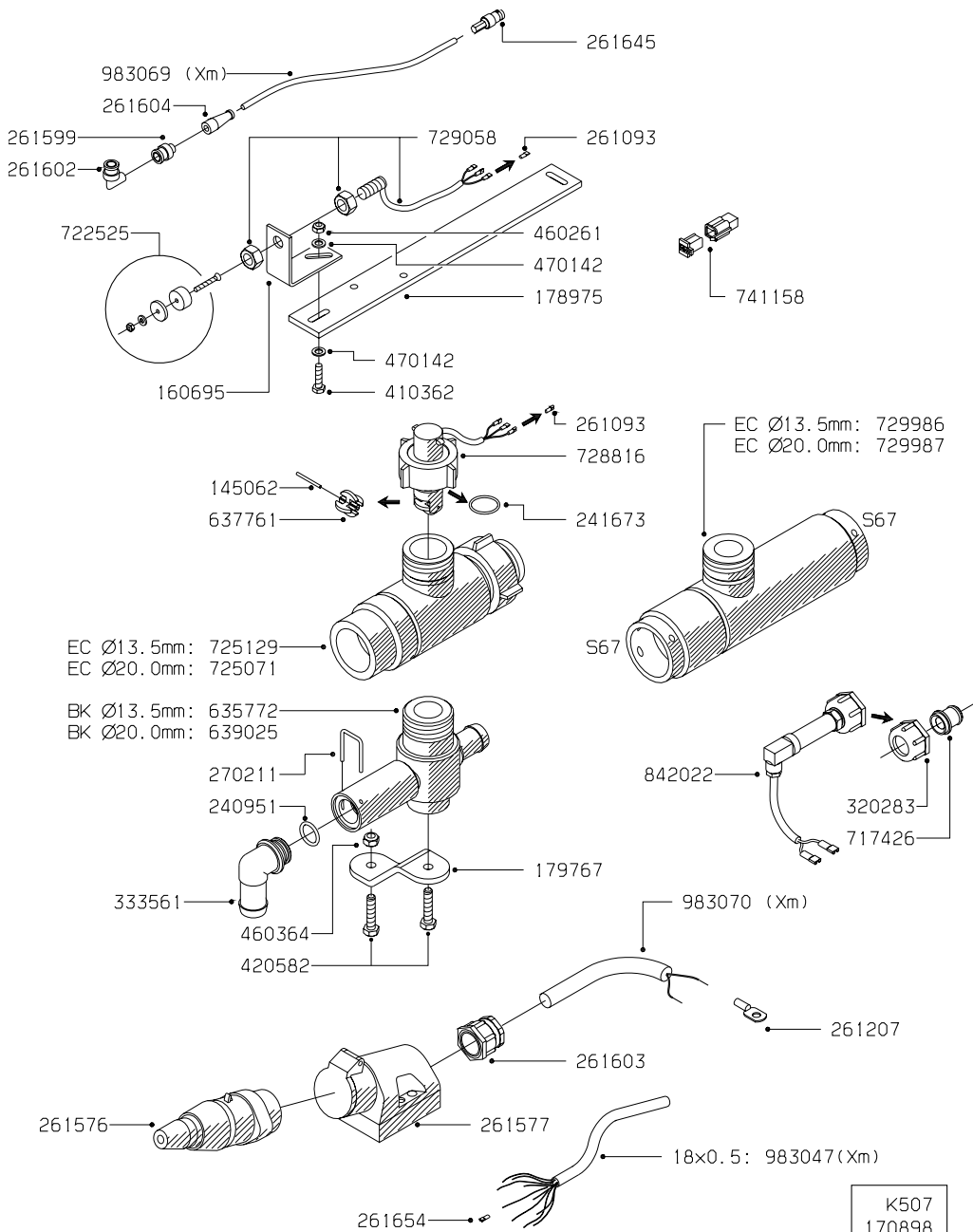

K507
170898

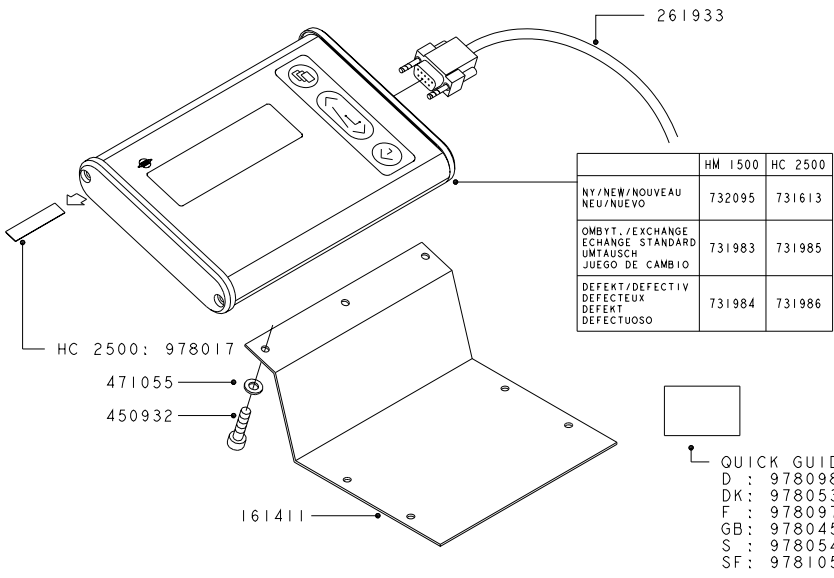

QUICK GUIDE
 D : 978098
 DK: 978053
 F : 978097
 GB: 978045
 S : 978054
 SF: 978105

